

⚠ Caution | Do not mark on the model and other components with pen nor leave printed materials contacted on surface.  
Ink marks on the models cannot be removed.

MW13

# Difficult Airway Management Simulator

— *Training Model* —

## Instruction Manual

### Contents

- Introduction ..... P. 1  
Manufacturer's Note  
DOs and DON'Ts
- Before You Start ..... P. 2  
Set Includes
- Before Training ..... P. 3  
Check points before training
- Preparation  
Setting of DAM (Neck flexibility) ..... P.4  
Setting of DAM (Degree of the mouth opening) ..... P. 5  
Setting of DAM (Tongue Edema) ..... P. 6  
Setting of DAM (Laryngospasm) ..... P. 7
- Training ..... P.8-P.10
- Replacement of the Consumable Parts ..... P.11-P.19
- After Training ..... P.20



Difficult Airway Management Simulator Light tone



Difficult Airway Management Simulator Dark tone

Movie Site



English Site

# Introduction

## Manufacturer's note

The Difficult Airway management (D.A.M.) Simulator offers not only excellent reality in airway management training but also varying degrees of challenge to trainees through a combination of controllable degree of mouth opening, changeable limit of neck flexibility, and inflatable tongue. It provides wide variations of training experiences in difficult airway management including use of diverse types of devices. Its portable design and durable structure allow training in emergency, pre-hospital, and clinical settings. This innovative simulator facilitates acquiring basic skills, improving the skills to advanced level and attaining ability to respond real-life situations.

### ● Features

- Robust structure and the stable base for training in various settings including those for pre-hospital scenario
- Anatomically correct airway structure and realistic laryngeal view
- The upper teeth are removable with excess force
- A variety of possible airway skills that include: intubation with a laryngoscope, BVM ventilation, nasal intubation, Laryngeal mask ventilation, and use of a video laryngoscope
- The optional bronchus model that allows for bronchofiberscopy training

This D.A.M simulator Training Model has been developed for the training of medical and paramedical professionals only. Any other use, or any use not in accordance with the enclosed instructions, is strongly discouraged. The manufacturer cannot be held responsible for any accident or damage resulting from such use. Please use this model carefully and refrain from subjecting to any unnecessary stress or wear. Should you have any questions on this simulator, please feel free to contact our distributor in your area or KYOTO KAGAKU at any time. (Our contact address is on the back cover of this manual)

## DOs and DON'Ts

### DOs

- Handle the manikin and the components with care.
- Storage in a dark, cool space will help prevent the skin colours from fading.
- The manikin skin may be cleaned with a wet cloth, if necessary, using mildly soapy water or diluted detergent.

### DON'Ts

- Do not let ink from pens, newspapers, this manual or other sources contact with the manikin, as they cannot be cleaned off the manikin skin.
- Never use organic solvent like paint thinner to clean the skin, as this will damage the simulator.
- Even if color on its surface might be changed across the ages, this does not affect the quality of its performance.

## Set Includes

Before you start, ensure that you have all components listed below.



- |                               |   |                                     |   |
|-------------------------------|---|-------------------------------------|---|
| a. Torso body                 | 1 | e. Syringe (50mL)                   | 1 |
| b. Replacement upper incisors | 2 | 1 bag for model, instruction manual |   |
| c. Replacement tongue II      | 1 |                                     |   |
| d. Lubricant                  | 1 |                                     |   |

### Consumable parts

code	name	code	name
11392-010	Upper incisors (set of 10)	11392-040-D	Chest cover Dark tone 1
11392-090	Face mask II Light tone 1	11392-050	Lung (right and left) (a set of 5)
11392-090-D	Face mask II Dark tone 1	11392-060	Stomach (a set of 5)
11392-080	Replacement tongue II 1	11229-050	Lubricant 1
11392-040	Chest cover Light tone 1		



11392-010



11392-090/090-D



11392-080



11392-040/040-D



11392-050



11392-060



11229-050

### Optional part

11384-100 Bronchofiberscope training unit



## 1 Check points before training

1. Open the mouth of the model to check the installation condition of the tongue.  
Ensure that the tongue has not fallen out from the pin.  
(When the product is delivered, the tongue has already been installed on the model.)



The tongue is correctly installed



The pin is fixed to the jaw side.

2. Turn up the skin of the model's neck to check whether the tongue fixing part and the throat part are correctly installed.

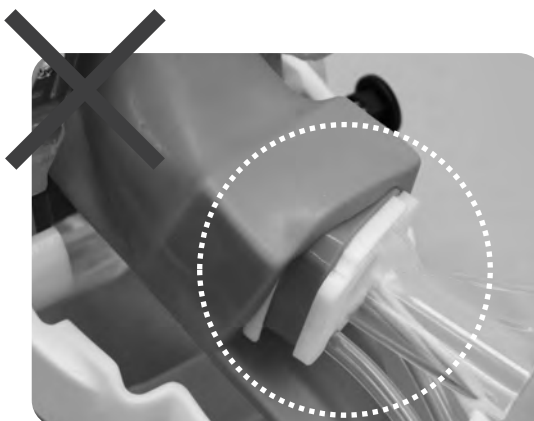

Incorrect installation

(\* The photo is taken while the head is removed to allow to see the condition clearly.)

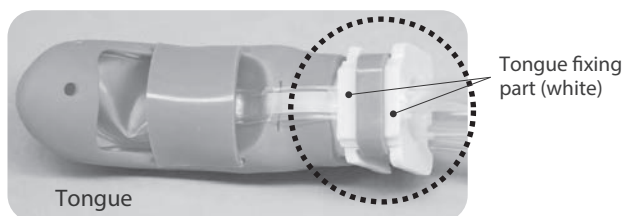
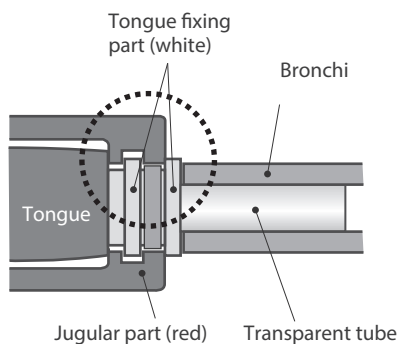

**Caution**

.....  
If the parts enclosed in the dotted circle are not correctly engaged with each other, the tongue will fall out during training.

3. Ready for training session.

## 1 Neck Flexibility

Change the range of motion of the neck with the black level-switching knobs on the both sides of the neck of the model.

Turn the knobs while pulling them to the outside to adjust the depth to which the knobs are inserted. You can select either of two levels of difficulty: normal neck and rigid neck.

1. To conduct training for the normal condition, align the knobs to the position where you can see the green seal as shown in the photo. Always set up the knobs on both sides identically to each other.

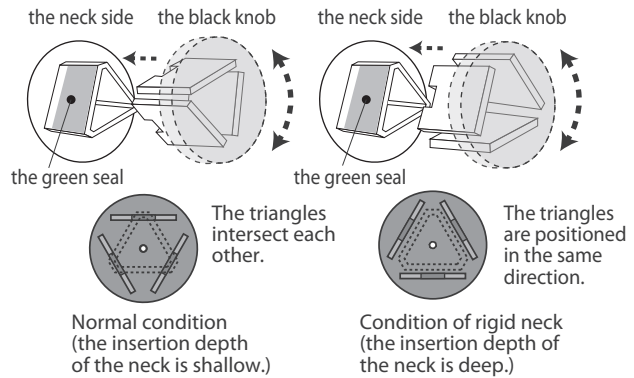

2. To change the setting to the condition of difficulty in neck recurvation, turn the knob while pulling it to align the foot of the triangle to the same direction as that of the receptacle parts on the model. Push the knob until the green seal disappears. You can also lock the setting by returning the position of the head to the direction indicated in the photo below.



.....  
**Conduct any training after setting the knobs on both sides to the same setting. If the knobs are set in different settings, it might cause breakage and/or failure.**



Normal



Rigid

### 1 Degree of the Mouth Opening

Set the mouth opening limitation with the black level-switching knob on the top of the head of the model. Move the knob up or down while pulling it, and then release it on either of the indicated level lines to lock the setting. You can select one of three levels of difficulty: Easy (Normal) [normal condition], Intermediate [mouth opening difficulty level 1] and Difficult [mouth opening difficulty level 2].

1. To conduct training for the normal condition, align the knob to the Easy (Normal) position.

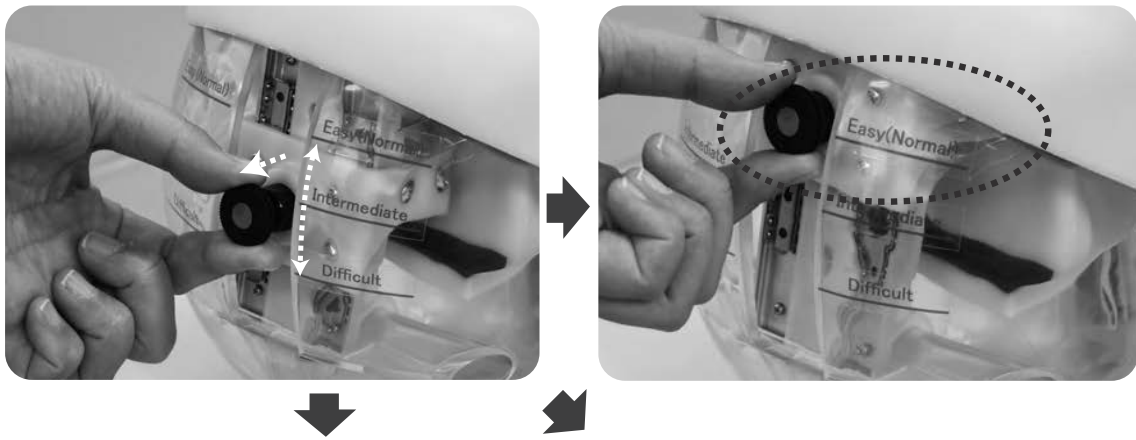

2. To change the condition of the mouth opening difficulty level, move the knob up while pulling it, and then release it on the Intermediate position [mouth opening difficulty level 1] or Difficult position [mouth opening difficulty level 2].



Normal (easy)



Intermediate



Difficult



### 1 Tongue Edema

To adjust the condition of the swollen tongue, inject/extract air to/from the tongue by using the attached syringe to change the size of the tongue.

The size of the tongue can be set in two levels: normal tongue and swollen tongue.

1. To set the tongue to normal condition, do not inject air.
2. To simulate the condition of swollen tongue, intake **20mL** of air into the attached syringe and then connect it to the flat tube located in the neck of the model. The syringe is provided with a lock mechanism. Insert the tip of the syringe to the connector on the end of the tube and then turn the syringe clockwise. After injecting the air into the tongue to simulate swollen tongue condition, turn the syringe counter-clockwise to detach it from the tube.

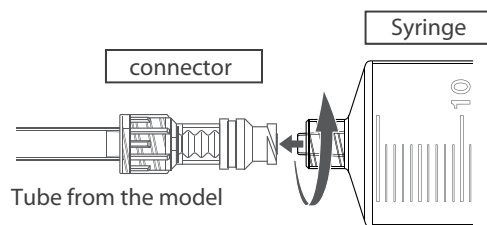

**Connecting** Rotate while pressing connector

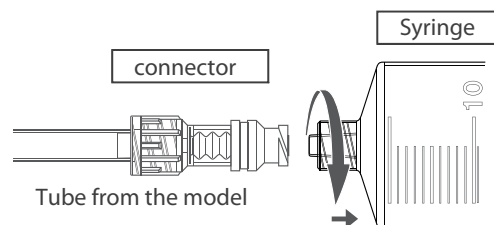

**Detaching** Rotate connector counter-clockwise

3. To restore the tongue to the normal condition, connect an empty syringe to the tube by using the procedure in the step 2 to extract the air in the tongue to restore the size of the tongue to normal.



Normal



Swollen

### 1 Laryngospasm

By pressing the pump on the end of the tube attached to the main body, you can simulate the laryngospasm.

1. The condition of laryngospasm is simulated while the pump is being pressed. The condition returns to normal when the pump is released.



The condition returns to normal when the pump is released.

Laryngospasm is simulated while the pump is being pressed.



\* The photos show the tongue component that is detached from the model to allow visibility of the condition.

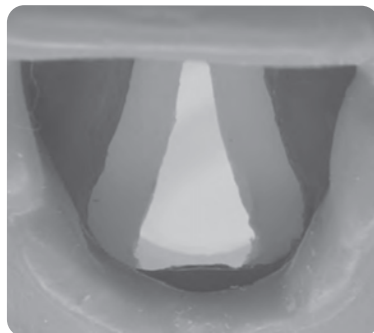

Normal

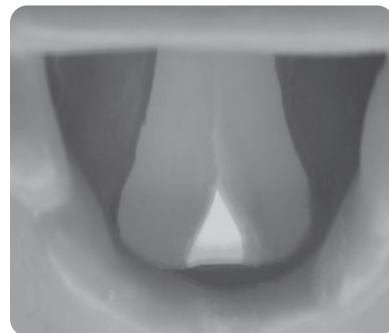

Laryngospasm



### 1 Airway Opening Techniques

True-to-life articulation allows for head-tilt/chin-lift and jaw-thrust techniques.



### 2 Bag-Valve-Mask ventilation

Successful ventilation can be confirmed by the movement of the chest.



### 3 Intraoral Intubation with Laryngoscope

Setting the head at "sniffing position", intubation with laryngoscope can be performed.  
The upper incisors are removable with excess force.



Put enough lubricant to the model before inserting the tracheal tube.  
For nasotracheal airway, spray the lubricant in the cavitas nasi and the tube. For oral route airway, in the mouth and the tube.



.....  
Recommended tools: Macintosh laryngoscope Size: No.3  
Tracheal tube: 7.0, 7.5 mm (inside diameter)  
Use the lubricant included in the set. Others like gel type may remain in the model and become irremovable.

### 4 Laryngeal mask ventilation

Put enough lubricant to the laryngeal mask and the oral cavity before training.



.....  
Recommended laryngeal mask:

type	size
LMA	4
i-gel	4

### 5 Confirmation Successful Intubation

The placement of the tube can be confirmed by auscultation or movement of thoracoabdominal area. (Five auscultation points are configured.)

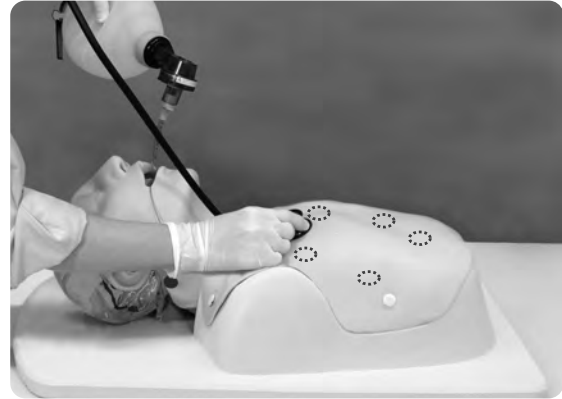

### 6 Intubation by the Video Laryngoscope

Put enough lubricant to the video laryngoscope and the oral cavity before training.



### 7 Securing the Tracheal Tube

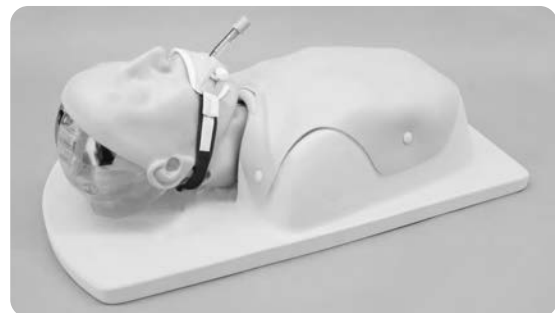

.....  
Do not leave the tapes on the model. If the tapes remain on the model for long time, its skin surface will become sticky with adhesive of tapes.

### 1 Upper Incisors

Widen the mouth and then place the protruded part behind the part where the incisor component is installed into the groove on the upper jaw.

Then push up the incisor component toward the front direction until you hear a "click" sound.



### 2 Tongue

1. Set the range of motion in neck recurvation to the normal condition. Then set the mouth opening limitation to the Easy (Normal) condition.

(Refer to P. 4 and P. 5 respectively for the setting procedures.)



Turn the black knob to the normal position where the green seal appears.



Move the black knob to the Easy (Normal) position.

### 2 Tongue

2. Remove the band of the back of the head and then remove the face mask from buttons at ears.



3. Remove the mask from the head.



4. Remove the chest skin.



5. Remove the chest cover.

Lift the chest cover by pulling up the upper part of the cover, and detach the tube connected to the back of the cover from the lung bag (two points) at first, then from the stomach bag. The tube can be detached by pulling down it while pushing up the ring in the connector part where the tube is connected as shown in the figure. Then remove the chest cover from the main body.



Pull out the esophagus (bronchi) tube from the stomach (lung)

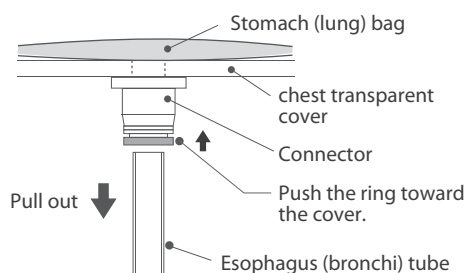

### 2 Tongue

6. Disconnect the transparent tube and bronchi part by pulling the bronchi part. Then disconnect the tube for laryngospasm.



7. To remove the tongue, pull the tongue to one side to expand the hole and remove from the pin.



8. Loosen the head connection bolts (there are two bolts).

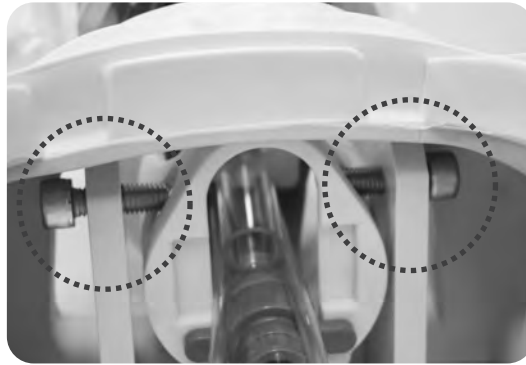

Insert a hand from the trunk side and loosen the connection bolts by rotating it counter-clockwise.



9. Pull the head horizontally to detach it from the trunk.

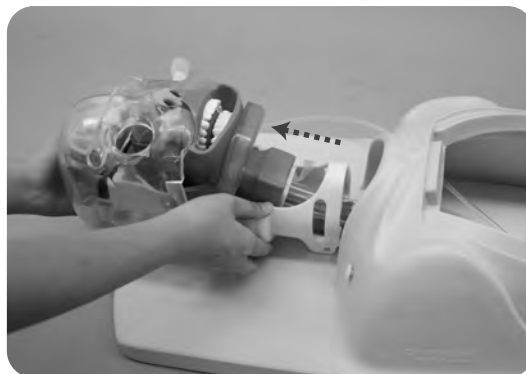

Caution

Loosen the bolts until the head can be detached. It is not necessary to loosen and remove it completely.



### 2 Tongue

10. Disengage the lower part of the throat from the tongue fixing part, then pull down the tongue component to detach. It becomes easy to pull out the whole tongue component when the tongue is pushed into the mouth while pulling it out.

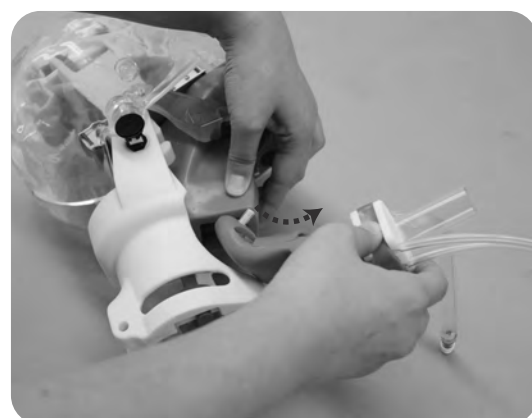
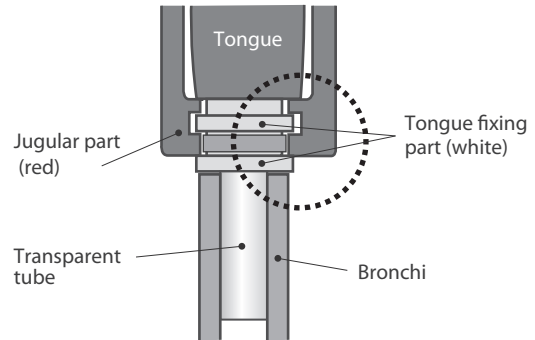

.....  
Slowly pull out the tongue component from the throat with care. If it is pulled out forcibly, it could break.

### 2 Tongue

11. After confirming the tongue direction, insert half of it into the throat from the opening. Insertion is more easily facilitated by applying training model lubricant on it.



12. Push the tongue component into the throat from the throat side. Open the mouth, hold the tongue when a certain portion of it comes into the oral cavity, then pull it until the tip of the tongue touches the incisors. Ensure that the air bag installed in the tongue is not displaced.

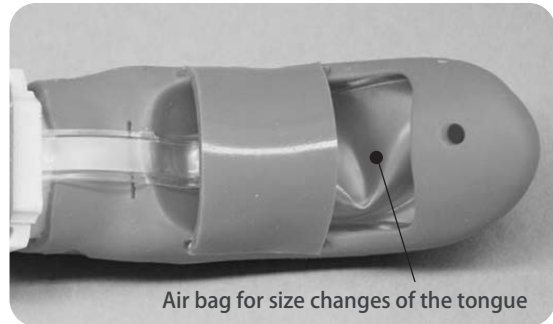

13. Widen the lower part of the throat and engage it with the lower part of the tongue fixing part. Ensure that the entire perimeter is engaged properly.

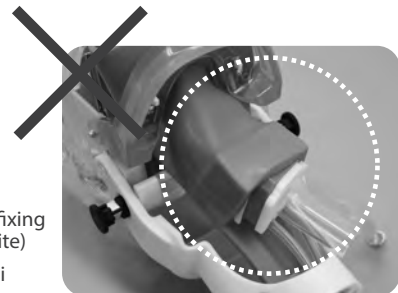
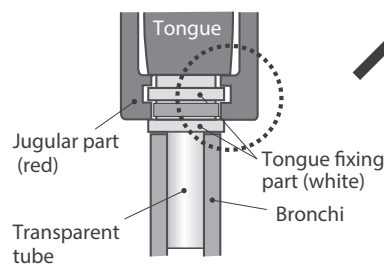

Example of inappropriate installation of tongue component

14. Hook one side of the hole on the tongue to the edge of the pin and pull the tongue in the opposite direction to expand the hole. Once the hole is large enough, fit the pin through the hole to secure the tongue in place.

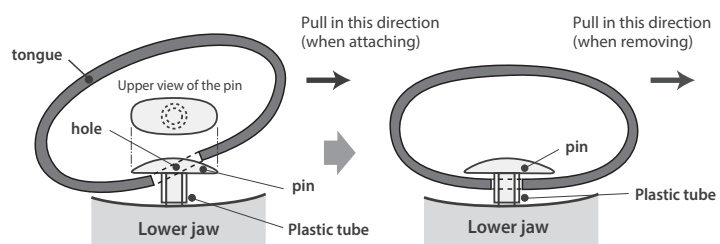

### 2 Tongue

15. Store the transparent pipe on the tongue component and the tube for laryngospasm simulation into the neck part.



16. Install the head to the trunk.



17. Align the slit on the neck and the bolt, then fasten the head connection bolts (there are two bolts) to connect the head with the trunk part.

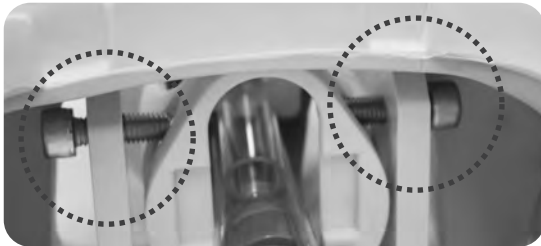

18. Connect the bronchus component.



19. Connect the laryngospasm tube.



20. Connect the stomach tube and the lung tube (at two points). The tube is fixed only by inserting it to the connector.



Ensure that the lung tube and the esophagus tube are connected correctly. The tube sizes are different.

Attach the esophagus (bronchi) tube to the stomach (lung) bag

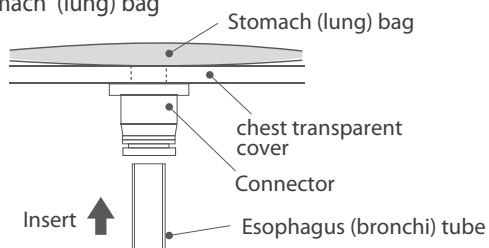

21. After installing the chest cover on the model, attach the chest skin and the mask. The mask must not lap over the neck flexibility setting knobs.



### 3 Face Mask and Chest Cover

#### Face mask

1. Remove the band of the back of the head and then remove the face mask from buttons at ears.
2. Take off the face mask .



3. Set the new mask on the face.
4. Tilt the head, run the band attached on a side of the occipital part of the face mask behind the neck, and put it into the hole on the skin of the other side. Fit the both of the ear holes on the mask to the head of the model.



#### Chest cover

1. Remove the cover from the buttons on shoulders and sides of the body.

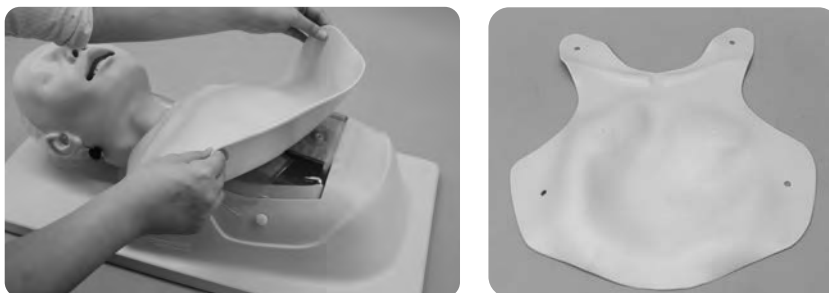

2. Set the new cover on the chest and fix it at the buttons on shoulders and sides of the body.



### 4 Lung Bag

1. Remove the chest cover.

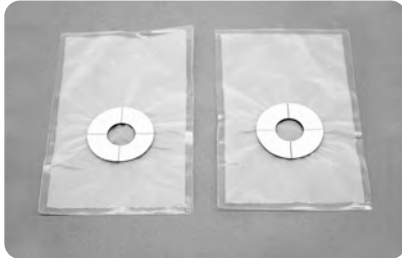

2. Take off the lung bag from the body. Ensure to remove the double-sided tape and adhesive left on the body.



3. Tear off the paper backing of the double-sided tape attached to the new lung bag, align the hole on the bag to the hole on the trunk part, and then tightly stick them together to avoid air leakage. After sticking them together, install the chest skin on the trunk component.

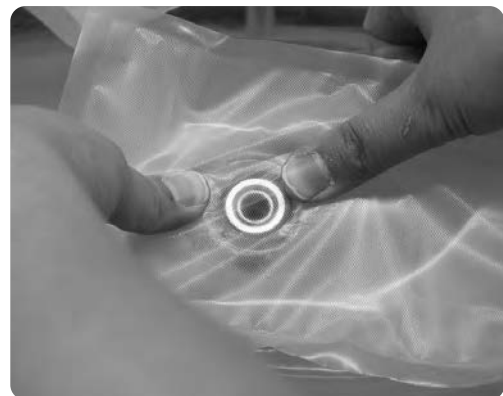



### 5 Stomach Bag

1. Remove the chest cover.



2. Take off the stomach bag from the body. Ensure to remove the double-sided tape and adhesive left on the body.



3. Tear off the paper backing of the double-sided tape attached to the new lung bag, align the hole on the bag to the hole on the trunk part, and then tightly stick them together to avoid air leakage. After sticking them together, install the chest skin on the trunk component.



 Caution

.....  
Stick the lung bag and the stomach bag together after aligning them into the correct direction as shown in the photos above.



# After Training

## After Training

Clean and remove the lubricant on the body with water or diluted detergent. Talcum powder may be used on the face mask and chest cover and body after use to preserve suppleness of the skin and prevent it from being stained. Before storage, ensure that model is dry.

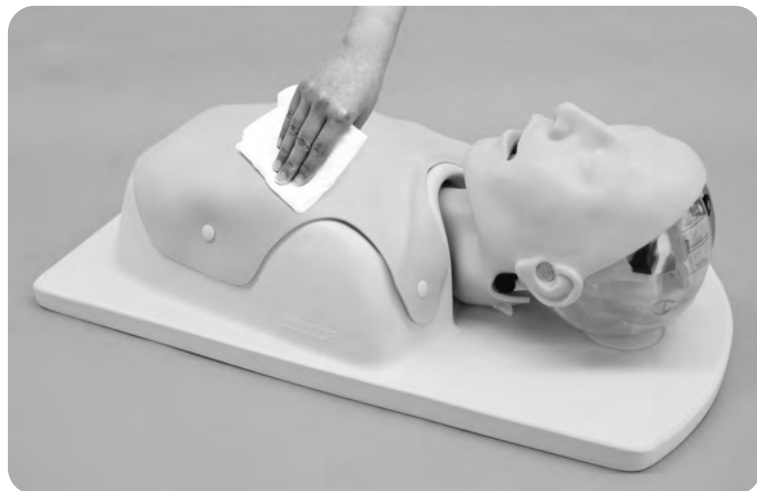
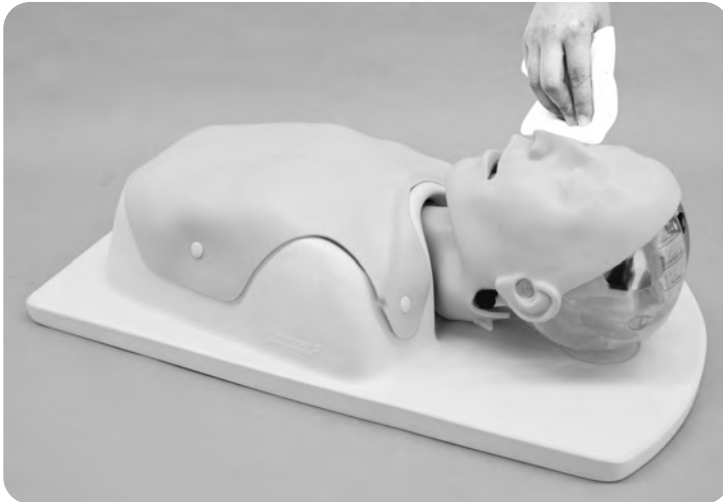



## Caution

Don't mark on the model and other components with pen or leave printed materials contacted on their surface.  
Ink marks on the models will be irremovable.

- For inquiries and service, please contact your distributor or KYOTO KAGAKU CO., LTD.

## **KYOTO KAGAKU co.,LTD**

<http://www.kyotokagaku.com> e-mail: [rw-kyoto@kyotokagaku.co.jp](mailto:rw-kyoto@kyotokagaku.co.jp)

### ■ Main Office and Factory

15 KitaneKoya-cho Fushimi-ku Kyoto 612-8388, Japan

Telephone : 81-75-605-2510

Facsimile : 81-75-605-2519

### ■ KyotoKagaku America Inc.

USA, Canada, and South America

3109 Lomita Boulevard, Torrance, CA 90505, USA

Telephone : 1-310-325-8860

Facsimile : 1-310-325-8867

---

The contents of the instruction manual are subject to change without prior notice.

No part of this instruction manual may be reproduced or transmitted in any form without permission from the manufacturer.

Please contact manufacturer for extra copies of this manual which may contain important updates and revisions.

Please contact manufacturer with any discrepancies in this manual or product feedback. Your cooperation is greatly appreciated.